

Thermostat with adjustable temperature



Description

Order Number:	301111
Brand Name:	SOLIFLEX
Colour:	Grey (RAL 7011)
Housing Material:	PC plastic
Ingress Protection:	IP 20
Note:	Hyst. 7±3K / Sw.Pt.tol ±4K
Approvals:	CE, cURus
UL File Number:	E358385

Technical Data

Operating Temperature Range:	-40°F - 176°F
Setting range:	14°F - 176°F
Mounting:	DIN Rail 35 mm
Dimensions A x B x C (D+E):	60 x 39 x 42.4 mm
Weight:	~ 65 g
Voltage / Frequency:	max. 250 V AC 16 A(res) / 2 A(ind) max. 72 V DC max. 30 W
Lifetime:	100,000 hrs.
Connection:	2-pole terminal, clamping torque 0.5 Nm max. solid wire - 2.5 mm ² max., stranded wire - 1.5 mm ² max.

Please click on the graphics to download.

More CAD drawings can be found under [Product Download](#).

> [Overview Product Group SOLIFLEX - accessories for safety inside enclosures](#)

Cut Out Dimension:

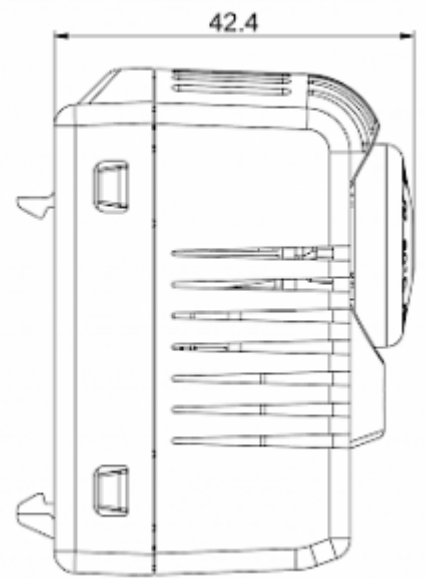
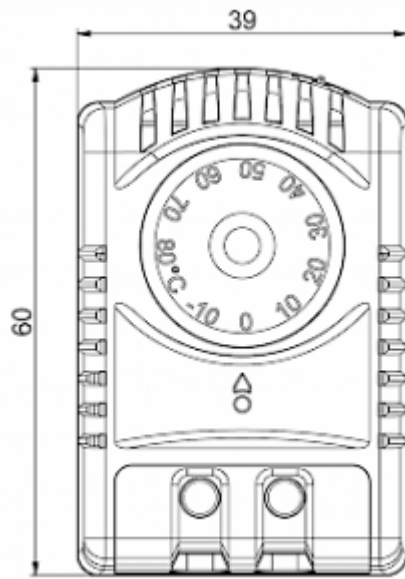

[click image to enlarge](#)